

Type: FORCA 4 T - Z

2015

438-041

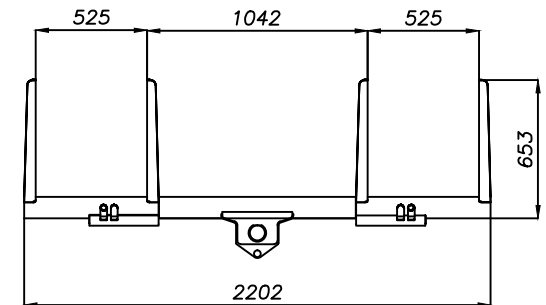
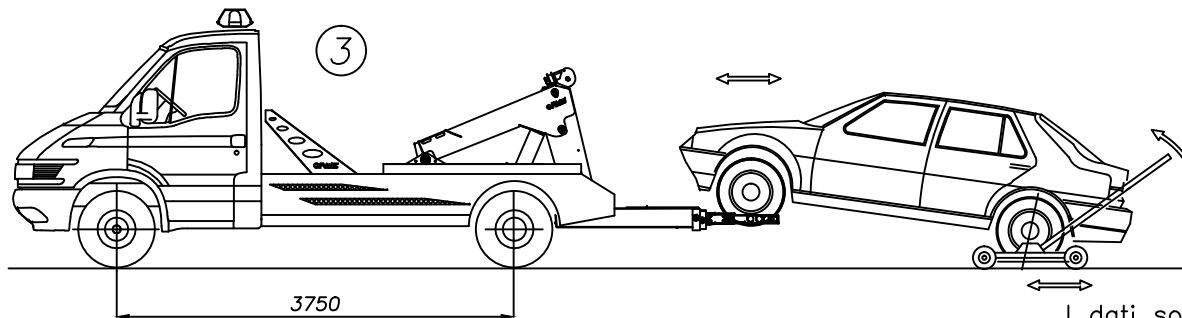
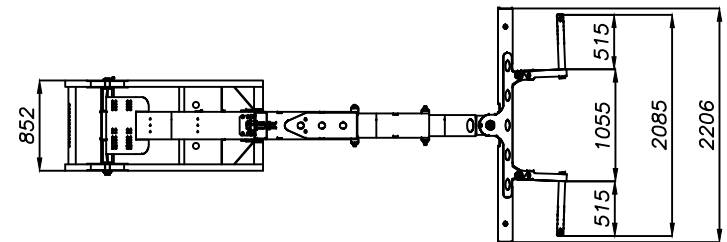
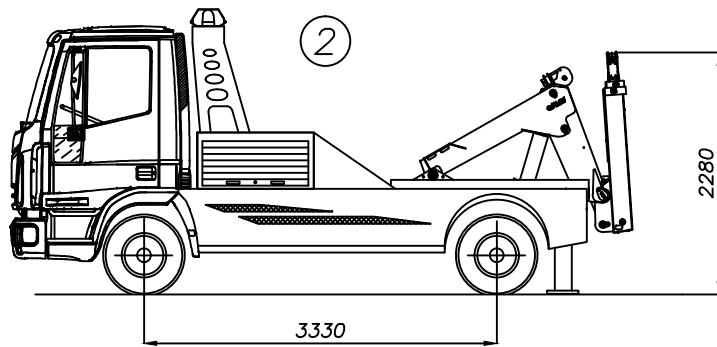
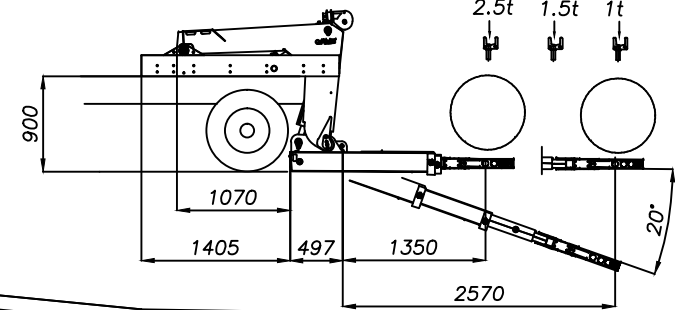
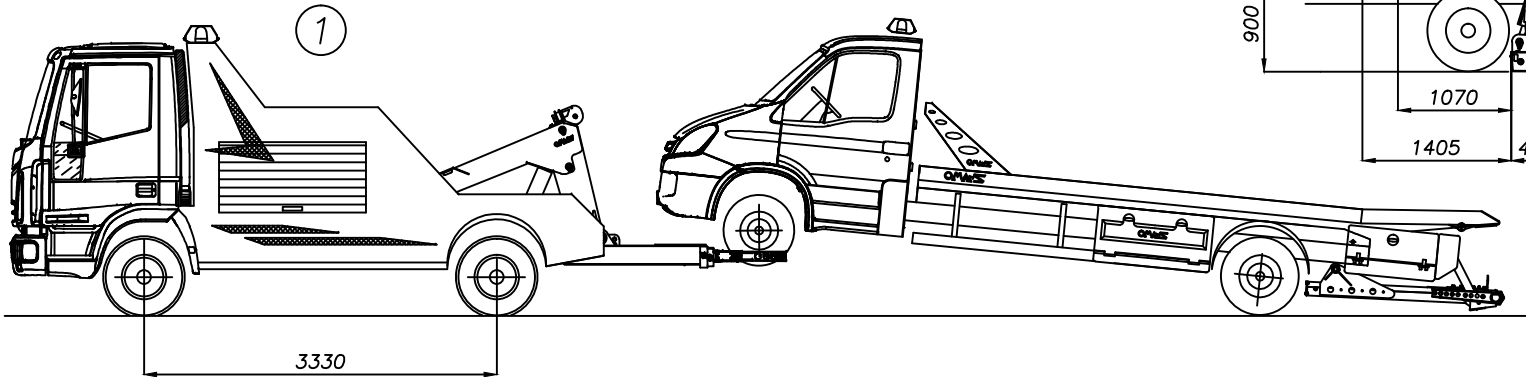

I dati sono indicativi e non impegnano la casa costruttrice